

PRODUCT SHEET

Description:

Floor Hinge "Jump III", W/Soft Close & Hold,SS304, 150KG, Brushed, 10-15mm Glass, Anti-Wind Capability,, Door Width: Max. 1300mm, Door Height: Max. 2200mm,, Door Weight: Max. 150 KG, Opening Angle:., 140° Bi-Directional, WorkingTemperature:-40~60oC

Item number:

15.24.268-0

Units	Box	Carton	HS Code	Barcode
Pcs.	1	6	8302100090	
				5704866485333

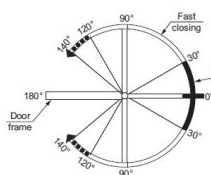
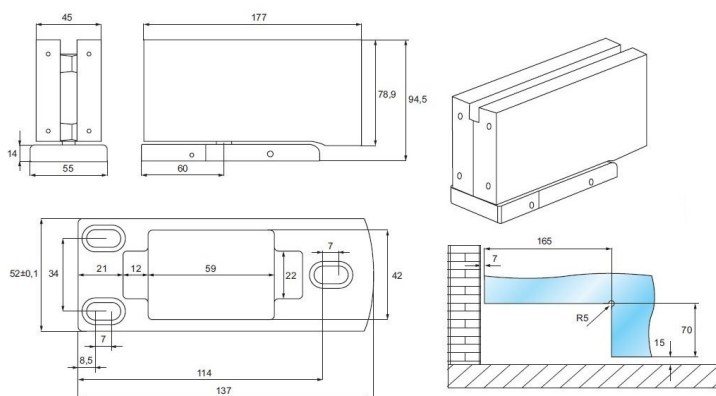
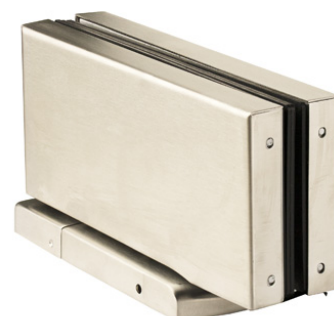

- Features:
1. Open angle: 140°
 2. Door hold open section: 90° and 140°-120° (Optional)
 3. Two speeds adjustable
Valve 1: 90°-0°
Valve 2: 30°-0°

Glass thickness	Application of rubber gasket Thickness (1.5 mm)
10 mm	4
12 mm	4
14 mm	2
16 mm	2

SISO A/S
Mileparken 11
DK-2740 Skovlunde
Denmark
VAT: DK 24786013

Phone +45 45 830 900
www.siso.dk
siso@siso.dk

Danske Bank
Nytorv Branch
Copenhagen
SWIFT: DABADKKK

Account no.
4180 3112 112936
IBAN Account
DK7230003112112936